



Yuasa Scheda Tecnica

Yuasa YB10L-A2 - YuMicron Batteria

Prestazione

Tensione	12V
Capacity (10-hour)	11Ah
Capacità (20 ore)	11.6Ah
CCA @ -18°C	120A

Dimensions (±2mm)

Lunghezza	135mm
Profondità	90mm
Altezza	145mm

Pesi e Misure

Peso medio con acido	4.2kg
Volume dell'acido	0.8l

Mounting Angle

Angle A	Vertical only
Angle B	-
Angle C	-

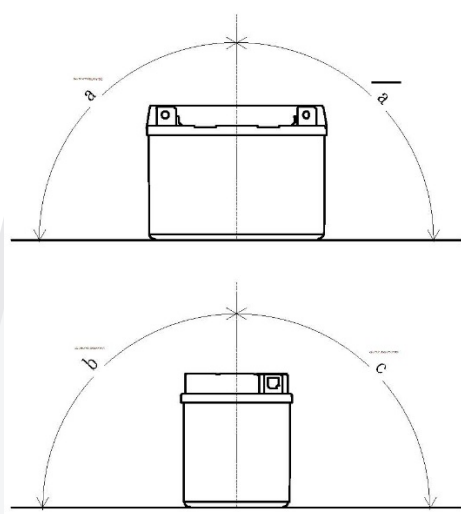

Tecnologia

Tecnologia
Separatore

Cast Sb/Sb
Synthetic Resin+Glass Fiber

Schema di Collegamento

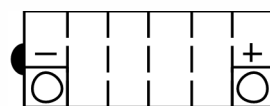

Tipologia dei terminali - 8



Scheda tecnica prodotta su E&OE



Yuasa Technical Data Sheet

Yuasa YB10L-A2 - YuMicron Battery

Performance

Voltage	12V
Capacity (10-hour)	11Ah
Capacity (20-hour)	11.6Ah
CCA @ -18°C	120A

Dimensions (±2mm)

Length	135mm
Width	90mm
Height	145mm

Weights & Measures

Mean Weight with Acid	4.2kg
Acid Volume	0.8l

Mounting Angle

Angle A	Vertical only
Angle B	-
Angle C	-

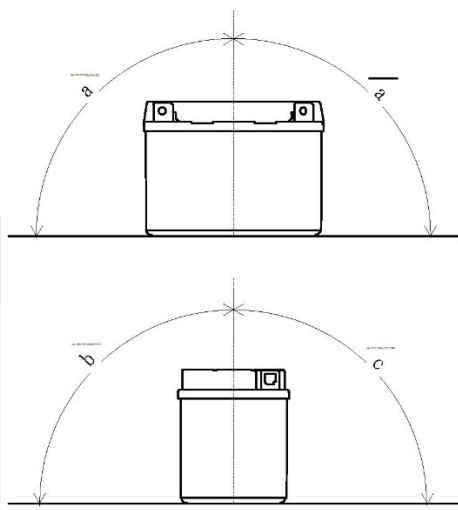

Technology

Technology	Cast Sb/Sb
Separator	Synthetic Resin+Glass Fiber

Cell Assembly Layout



Terminal Type - 8



Data Sheet generated on 14/03/2017 - E&OE