



Yuasa Scheda Tecnica

Yuasa YB4L-B - YuMicron Batteria

Prestazione

Tensione	12V
Capacity (10-hour)	4Ah
Capacità (20 ore)	4.2Ah
CCA @ -18°C	45A

Dimensions ($\pm 2\text{mm}$)

Lunghezza	121mm
Profondità	71mm
Altezza	93mm

Pesi e Misure

Peso medio con acido	1.5kg
Volume dell'acido	0.3l

Mounting Angle

Angle A	Vertical only
Angle B	-
Angle C	-

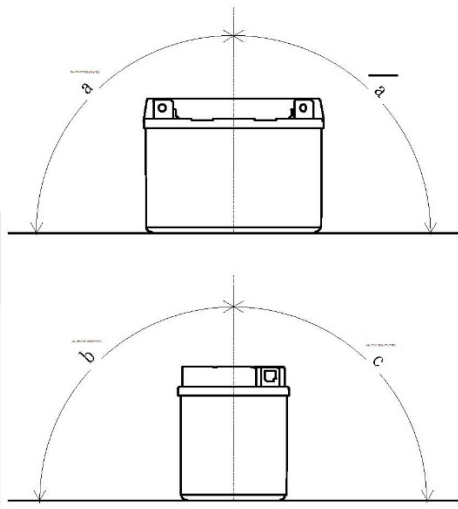

Tecnologia

Tecnologia Separatore

Cast Sb/Sb Leaf

Schema di Collegamento

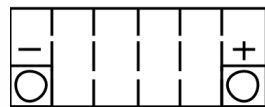

Tipologia dei terminali - 5



Scheda tecnica prodotta su E&OE



Yuasa Technical Data Sheet

Yuasa YB4L-B - YuMicron Battery

Performance

Voltage	12V
Capacity (10-hour)	4Ah
Capacity (20-hour)	4.2Ah
CCA @ -18°C	45A

Dimensions (±2mm)

Length	121mm
Width	71mm
Height	93mm

Weights & Measures

Mean Weight with Acid	1.5kg
Acid Volume	0.3l



Mounting Angle

Angle A	Vertical only
Angle B	-
Angle C	-

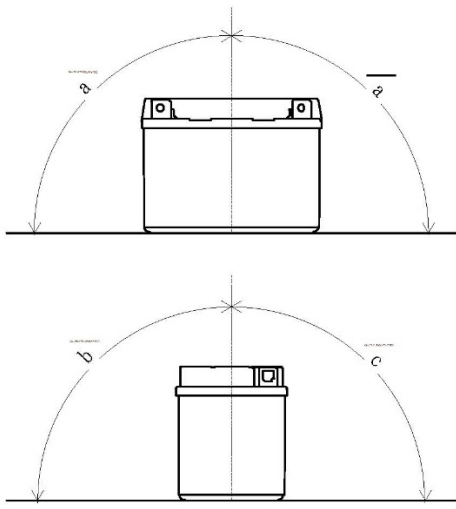

Technology

Technology	Cast Sb/Sb
Separator	Leaf

Cell Assembly Layout



Terminal Type - 5



Data Sheet generated on 09/03/2017 - E&OE