



## Yuasa Scheda Tecnica

### Yuasa YTZ10S - High Performance Maintenance Free Batteria

#### Prestazione

Tensione	12V
Capacity (10-hour)	8.6Ah
Capacità (20 ore)	9.1Ah
CCA @ -18°C	190A

#### Dimensions (±2mm)

Lunghezza	150mm
Profondità	87mm
Altezza	93mm

#### Pesi e Misure

Peso medio con acido	3.2kg
----------------------	-------

#### Mounting Angle

Angle A	40°
Angle B	90°
Angle C	15°

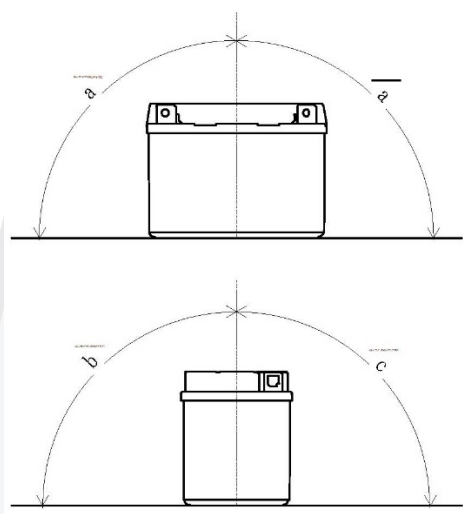

#### Tecnologia

Tecnologia  
Separatore

Exp Ca/Ca  
AGM

#### Schema di Collegamento

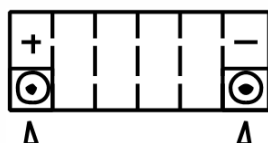

#### Tipologia dei terminali - 11



Scheda tecnica prodotta su E&OE



## Yuasa Technical Data Sheet

### Yuasa YTZ10S - High Performance Maintenance Free Battery

#### Performance

Voltage	12V
Capacity (10-hour)	8.6Ah
Capacity (20-hour)	9.1Ah
CCA @ -18°C	190A

#### Dimensions (±2mm)

Length	150mm
Width	87mm
Height	93mm

#### Weights & Measures

Mean Weight with Acid	3.2kg
-----------------------	-------

#### Mounting Angle

Angle A	40°
Angle B	90°
Angle C	15°

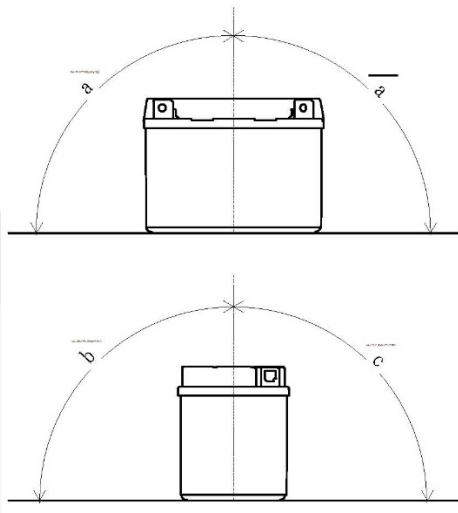

#### Technology

Technology  
Separator

Exp Ca/Ca  
AGM

#### Cell Assembly Layout

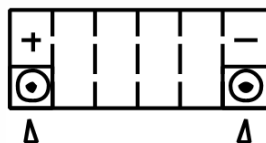

#### Terminal Type - 11



Data Sheet generated on 09/03/2017 - E&OE